

R4X Floor Box

The R4X raised floor box can be configured to accept six, seven or eight gang faceplates providing the perfect solution for any project size.

Made of 16 Ga. galvanized steel, the powder coating adds extra corrosion protection and a pleasant aesthetic look.

The floor box covers are available in solid brass and stainless steel, both provided with a recessed space for the floor covering material. The 7/16" (12 mm) recessed space accepts the installation of carpet, terrazzo, tile etc.

Two cable guards protect and reduce risk of damage to all incoming and outgoing cables. The cover is provided with a slotted retractable handle to facilitate the access to services.



R4XSRB Floor Box

Features

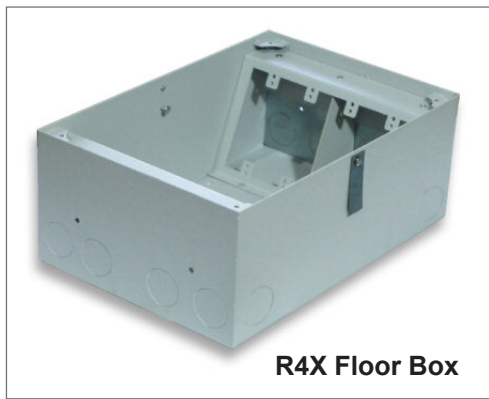

R4X Floor Box

Note: The kit includes the floor box and cover. Faceplates sold separately.

- Three different versions available to accept six, seven or eight gang.
- 16 Knockout's (8 per compartment) for 1" conduits.
- Made in U.S.A.
- Removable barriers separate circuits.
- Manufactured in compliance with UL514A Standard.
- Easy installation in low profile raised floors (5" depth).
- 16 GA Powder coated galvanized steel housing - Provides added strength and reliability.
- The painted interior offers a professional and highly aesthetic look.
- Locking clips - Quick and secure installation to different floor thicknesses.
- Non-Painted knockouts area assures proper bonding and facilitates the installation process.

	Length	Width	Height
Floor Box	12 5/8" (320 mm)	8 5/8" (220 mm)	5" (126 mm)
Cover	13 5/16" (338 mm)	9 7/16" (240 mm)	3/16" (4 mm)



R4X Floor Box



R4X Floor Box Cover







- Solid cover Material: Stainless steel or brass (brushed finish)
- Removable and reversible lid - Can be easily rotated.
- 7/16" (12 mm) Rectangular recess - Permits to install floor covering materials of different thicknesses.
- Retractable handles facilitate access to box services.
- Quick installation. No visible screws when closed.
- Cable guards with rubber foam and handle - Can be tilted when in use or closed when not used.
- Low profile beveled flange - Hide edges of hard surface flooring and prevents the carpet from fraying providing a seamless, smooth finish.

Connectivity Options

Based on the quantity of devices required, the floor box is assembled with six, seven or eight gang panels, taking the R46, R47 and R48 prefix accordingly. Wallplates for standard duplex receptacles and decorator (GFCI) style are offered in the single gang, two gang and four gang versions providing the perfect solution to accept most device combinations.

The decorator style wallplates offer a convenient solution for low voltage applications when used with the decorator style inserts. Our decorator style inserts accept up to six keystone jacks.

Inserts with VGA and others non-keystone style connectors are also available. (See Page 49 for details)

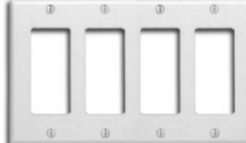
Image	Part Number	Image	Part Number	Image	Part Number
	# W6011 Single Gang Duplex Style UL Listed		# W6012 Two Gang Duplex Style UL Listed		# W6014 Four Gang Duplex Style UL Listed
	# W6121 Single Gang Decor Style UL Listed		# W6122 Two Gang Decor Style UL Listed		# W6124 Four Gang Decor Style UL Listed

How to select the right wallplates? Select the wallplates required in accordance to the following guidance:

R4X Floor Box

Connectivity Options

The R4X is available on three different floor box capacities / versions. Based on the devices and wallplates required for your project select the R46, R47 or R48 floor box. See the following guide for details:

Exploded view

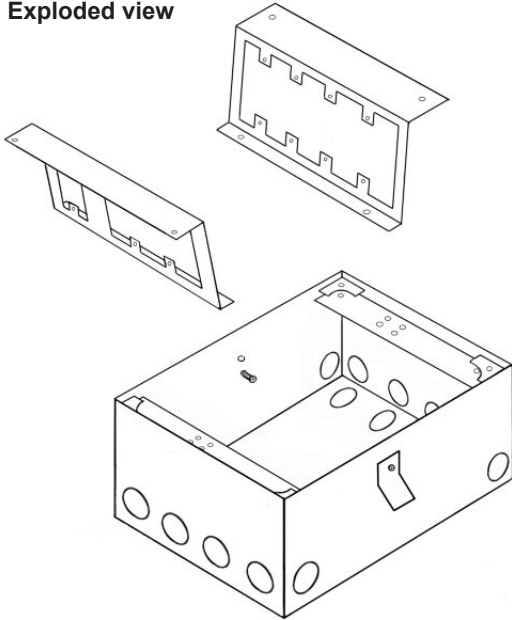

How to select the right wallplates?

■ R46 -Six gang box accepts:

Side A: (Qty: 1) Two gang wallplate + (Qty: 1) One gang wallplate.
Side B: (Qty: 1) Two gang wallplate + (Qty: 1) One gang wallplate.

■ R47 -Seven gang box accepts:

Side A: (Qty:1) Two gang wallplate + (Qty:1) One gang wallplate.
Side B: (Qty:1) Four gang wallplate.

■ R48 -Eight gang accepts:

Side A: (Qty: 1) Four gang wallplate.
Side B: (Qty: 1) Four gang wallplate.

*Wallplates sold separately.

*Removable barrier separates the one gang and two gang compartments on the R46 and R47 floor boxes.
 (Barrier sold separately) - **Barrier Part # BDPC4**

Ordering Information

The R4X floor box and cover are sold as a kit. Please select the kit number in accordance to the box capacity and cover that best suits your requirements. Wallplates sold separately.

Part #	# of Gang	Cover Material	Cover Type	Edge Type
R46 BRB	6	Brass	Recessed	Beveled
R47 BRB	7	Brass	Recessed	Beveled
R48 BRB	8	Brass	Recessed	Beveled
R46 SRB	6	Stainless Steel	Recessed	Beveled
R47 SRB	7	Stainless Steel	Recessed	Beveled
R48 SRB	8	Stainless Steel	Recessed	Beveled

Recessed: Accepts an insert of the floor covering material into the recessed top surface.

Beveled edges: Flange has rounded edges. The flange is installed on top of the floor covering material, hiding edges of hard surface flooring and also prevents the carpet from fraying when installed on carpet covered floors.